



NA016

FEEDER PROTECTION RELAY

THE ECONOMICAL SOLUTION FOR THE PROTECTION OF LINES AND TRANSFORMERS

— Application

The relay type NA016 can be used in radial networks as feeder or power transformer protection. In solidly grounded systems the residual overcurrent protection can be used on feeders of any length, while in ungrounded or Petersen coil and/or resistance grounded systems, the residual overcurrent protection can be used on feeders of small length in order to avoid unwanted trippings due to the capacitive current contribution of the feeder on external ground fault.

The NA016 protection relay may be shipped with traditional CTs or low power (LPCT) current inputs. The relay complies with CEI 0-16 requirements.

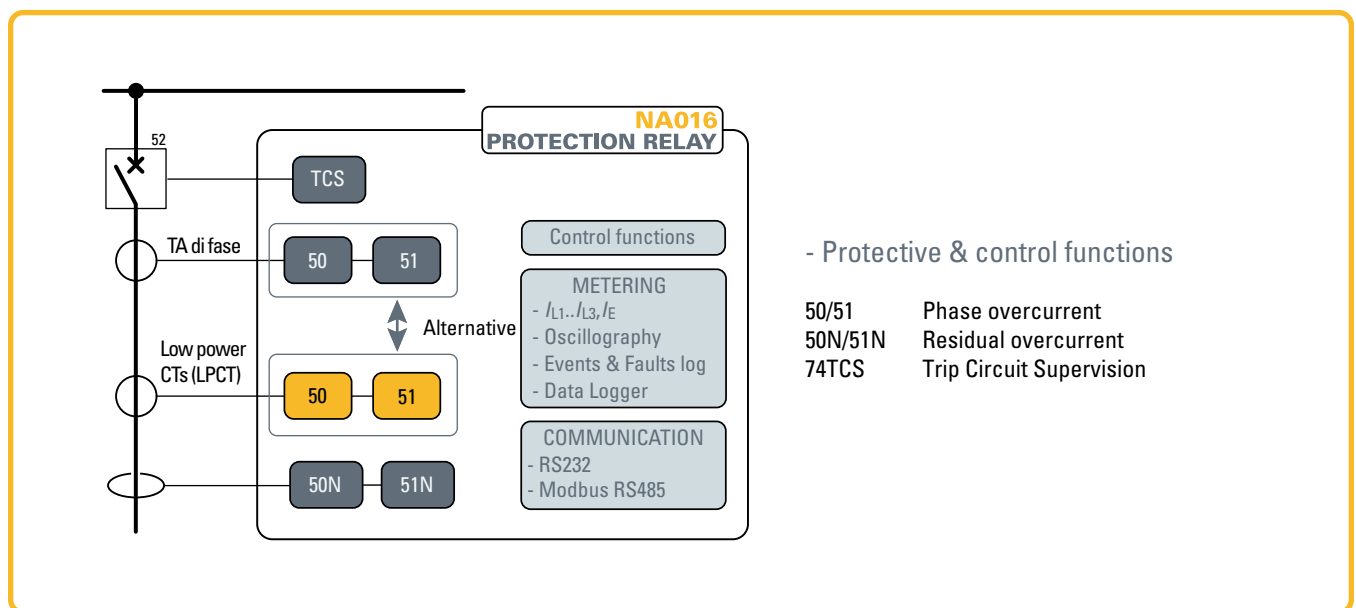

— **Measuring inputs**

Three phase current inputs and one residual current input, with nominal currents independently selectable at 1 A or 5 A (traditional CTs) or three phase currents for low-power CT (LPCT) with selectable rated current.

— **Output relays**

Four output relays are available (two changeover contacts); each relay may be individually programmed as normal state (normally energized or de-energized) and reset mode (manual or automatic).

A programmable timer is provided for each relay (minimum pulse width). The user may program the function of each relay in accordance with a matrix (tripping matrix) structure.

— **Binary inputs**

Three binary inputs are available with predefined functions:

- IN1 acquisition of 52b auxiliary contact for CB position capture
- IN2 acquisition of 52a auxiliary contact for CB position capture
- IN3 Trip circuit Supervision (TCS).

— **Construction**

The NA016 protection relay case is suitable for flush or rack mounting.

— **MMI (Man Machine Interface)**

The user interface comprises a membrane keyboard ^[1], a back-light LCD alphanumeric display and eight LEDs.

- The green ON LED indicates auxiliary power supply and self diagnostics,
- The yellow LED START, no-latched, indicates Start of the I>, I>>, I>>>, IE>, IE>> elements
- The red LED TRIP, no-latched, indicates Trip of the I>, I>>, I>>>, IE>, IE>> elements
- The red LED 1, latched, indicates Trip of the I>, I>>, I>>> elements
- The red LED 2, latched, indicates Trip of the IE>, IE>> elements
- The red LED 3, no-latched, indicates the 52a state (CB position)^[2]
- The red LED 4, no-latched, indicates the 52a state (CB position)^[2]
- The red LED 5, no-latched, indicates the TCS state^[2].

Note 1 - Keys **O** (CB open) and **I** (CB close) are disabled

Note 2 - Enabled only with Logger option



— **Metering**

NA016 provides metering values for phase and residual currents, making them available for reading on a display or to communication interfaces.

Input signals are sampled 64 times per period and the RMS value of the fundamental component is measured using the DFT (Discrete Fourier Transform) algorithm and digital filtering.

The measured signals can be displayed with reference to nominal values or directly expressed in amperes.

— **Self diagnostics**

All hardware and software functions are repeatedly checked and any anomalies reported via display messages, communication interfaces, LEDs and output relays.

Anomalies may refer to:

- Hw faults (auxiliary power supply, output relay coil interruptions, ...).
- Sw faults (boot and run time tests for data base, EEPROM memory checksum failure, data BUS,...).

— **Firmware updating**

The use of flash memory units allows on-site firmware updating.

— **Programming and settings**

All relay programming and adjustment operations may be performed through MMI (Keyboard and display) or using a Personal Computer with the aid of the ThyVisor software.

The same PC setup software is required to set, monitor and configure all Pro_N devices.

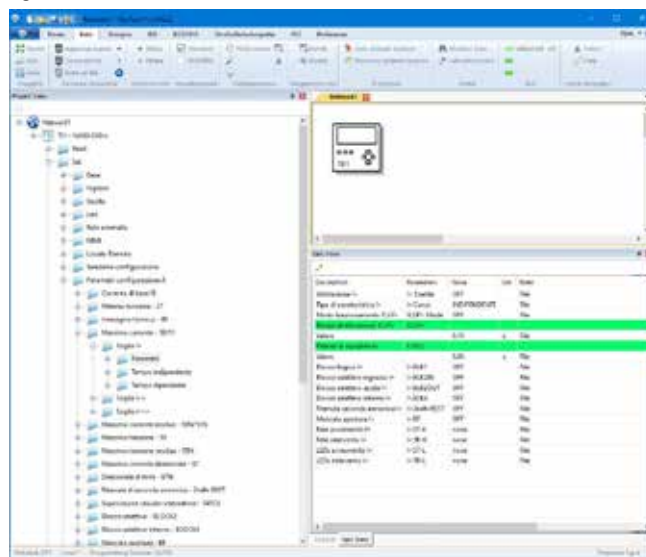

— **Data storage^[3]**

Several useful data are stored into a non volatile memory.

- Sequence of Event Recorder
The event recorder runs continuously capturing in circular mode the last one hundred events upon trigger of binary input/output.
- Sequence of Fault Recorder
The fault recorder runs continuously capturing in circular mode the last twenty faults upon trigger of binary input/output and/or element pickup (start-trip).
- Settings recording
Following some setting changes the last ten changes are recorded in circular mode (Data Logger CEI 0-16)
- Trip counters

Note 3 - The data-logger is available according to the CEI 0-16 standard; version with Logger must be requested when ordering.

— **Communication**

Two communication interfaces are implemented:

- One RS232 local communication front-end interface for communication with ThyVisor setup software
- One RS485 port using ModBus® RTU or IEC 60870-5-103 for communication with remote monitoring and control systems.

— **Digital Fault Recorder (Oscillography)^[4]**

Upon trigger of tripping/starting of each function or external signals, the relay records in COMTRADE format:

- Oscillography with instantaneous values for transient analysis.
- RMS values for long time periods analysis.
- Logic states (binary inputs and output relays).

Note 4 - A licence for the digital fault recorder function is required. The oscillography records are stored in non-volatile memory.

SPECIFICATIONS

GENERAL

— Mechanical data	
Mounting:	flush, rack
Mass (flush mounting case)	1.2 kg
— Insulation tests	
Reference standards	EN 60255-5
High voltage test 50Hz	2 kV 60 s
Impulse voltage withstand (1.2/50 μ s)	5 kV
Insulation resistance	>100 M Ω
— Voltage dip and interruption	
Reference standards	EN 61000-4-29
— EMC tests for interference immunity	
1 MHz damped oscillatory wave	EN 60255-22-1 1 kV-2.5 kV
Electrostatic discharge	EN 60255-22-2 8 kV
Fast transient burst (5/50 ns)	EN 60255-22-4 4 kV
Conducted radio-frequency fields	EN 60255-22-6 10 V
Radiated radio-frequency fields	EN 60255-4-3 10 V/m
High energy pulse	EN 61000-4-5 2 kV
Magnetic field 50 Hz	EN 61000-4-8 1 kA/m
Damped oscillatory wave	EN 61000-4-12 2.5 kV
Ring wave	EN 61000-4-12 2 kV
Conducted common mode (0...150 kHz)	EN 61000-4-16 10 V
— Emission	
Reference standards	EN 61000-6-4 (ex EN 50081-2)
Conducted emission 0.15...30 MHz	Class A
Radiated emission 30...1000 MHz	Class A
— Climatic tests	
Reference standards	IEC 60068-x, ENEL R CLI 01, CEI 50
— Mechanical tests	
Reference standards	EN 60255-21-1, 21-2, 21-3
— Safety requirements	
Reference standards	EN 61010-1
Pollution degree	3
Reference voltage	250 V
Overvoltage	III
Pulse voltage	5 kV
Reference standards	EN 60529
Protection degree:	
• Front side	IP52
• Rear side, connection terminals	IP20
— Environmental conditions	
Ambient temperature	-25...+70 °C
Storage temperature	-40...+85 °C
Relative humidity	10...95 %
Atmospheric pressure	70...110 kPa
— Certifications	
Product standard for measuring relays	EN 50263
CE conformity	
• EMC Directive	2004/108/EC
• Low Voltage Directive	2006/95/EC
Type tests	IEC 60255-6

COMMUNICATION INTERFACES

Local PC RS232	19200 bps
RS485 port	1200...57600 bps
Protocol	ModBus® RTU/IEC 60870-5-103

INPUT CIRCUITS

— Auxiliary power supply Uaux	
Nominal value (range)	24...230 Vac/dc
Operative range	19...265 Vac / 19...300 Vdc
Power consumption (max)	6 W (9 VA)
— Phase current inputs	
Traditional CTs:	
• Nominal current I_n	1 A or 5 A selectable by DIP Switches
• Permanent overload	25 A
• Thermal overload (1 s)	500 A
• Rated consumption (for any phase)	≤ 0.002 VA ($I_n = 1$ A) ≤ 0.04 VA ($I_n = 5$ A)
• Connections	4 mm ring lugs suitable for M4 screws
Low power CTs (according to IEC 60044-8 standard):	
• Nominal primary current I_{np}	100 A
• Extended primary current (selectable via DIP Switches and sw)	50...1250 A
• Maximum primary current	12.5 kA
• Nominal secondary voltage ($I_{pr} = 100$ A)	22.5 mV
• Connections	RJ45 plug
— Residual current input	
Nominal current I_{En}	1 A or 5 A selectable by DIP Switch
Permanent overload	25 A
Thermal overload (1s)	500 A
Rated consumption	≤ 0.006 VA ($I_{En} = 1$ A) ≤ 0.012 VA ($I_{En} = 5$ A)
— Binary inputs	
Quantity	3
Type	dry inputs
Max permissible voltage	19...265 Vac/19...300 Vdc
Max consumption, energized	3 mA

OUTPUT CIRCUITS

— Output relays K1...K4	
Quantity	4
Command relays K1, K2, K4	
Type of contacts	changeover (SPDT, type C)
Nominal current	8 A
Nominal voltage/max switching voltage	250 Vac/400 Vac
Breaking capacity:	
• Direct current (L/R = 40 ms)	50 W
• Alternating current ($\lambda = 0,4$)	1250 VA
Make	1000 W/VA
Short duration current (0,5 s)	30 A
Signalling relays K3	
Type of contacts	changeover (SPDT, type C)
Nominal current	8 A
Nominal voltage/max switching voltage	250 Vac/400 Vac
— LEDs	
Quantity	8
• ON/fail (green)	1
• Start (yellow)	1
• Trip (red)	1
• Trip $I>$, $I>>$, $I>>>$ (red)	1
• Trip $IE>$, $IE>>$ (red)	1
• 52a - CB position (red) ^[1]	1
• 52b - CB position (red) ^[1]	1
• TCS - Trip Circuit Supervision (red) ^[1]	1

Note 1 - Available for versions with data-logger only.

GENERAL SETTINGS

Rated values

Phase CT nominal primary current (I_{np})	1 A...1000 A
Residual CT nominal primary current (I_{Enp})	1 A...1000 A
Reading	Direct / Relative

Relay output timers

Minimum pulse width (t_{TR})	0.01...0.50 s
----------------------------------	---------------

PROTECTIVE FUNCTIONS

Phase overcurrent - 50/51

$I >$ Element

• $I >$ Curve type ($I >$ Curve)	IEC/BS A, B, C
• 50/51 First threshold inverse time ($I >_{inv}$)	0.100...2.50 I_n
• $I >_{inv}$ Operating time ($t >_{inv}$)	0.02...60.0 s

$I >>$ Element

• 50/51 Second threshold definite time ($I >>_{def}$)	0.100...20.0 I_n
• $I >>_{def}$ Operating time ($t >>_{def}$)	0.03...10.00 s
• $I >>$ Reset time delay ($t >>_{RES}$)	0.00...1.00 s

$I >>>$ Element

Definite time

• 50/51 Third threshold definite time ($I >>>_{def}$)	0.100...20.0 I_n
• $I >>>_{def}$ Operating time ($t >>>_{def}$)	0.03...10.00 s
• $I >>>$ Reset time delay ($t >>>_{RES}$)	0.00...1.00 s

Residual overcurrent - 50N/51N

$I_E >$ Element

• 50N/51N First threshold definite time ($I_E >_{def}$)	0.005...5.00 I_{En}
• $I_E >_{def}$ Operating time ($t_E >_{def}$)	0.03...180 s
• $I_E >$ Reset time delay ($t_E >_{RES}$)	0.00...1.00 s

$I_E >>$ Element

Definite time

• 50N/51N Second threshold definite time ($I_E >>_{def}$)	0.005...5.00 I_{En}
• $I_E >>_{def}$ within CLP ($I_{ECLP >>_{def}}$)	0.02...10.00 I_{En}
• $I_E >>_{def}$ Operating time ($t_E >>_{def}$)	0.03...10.00 s
• $I_E >>$ Reset time delay ($t_E >>_{RES}$)	0.00...1.00 s

Circuit Breaker

BF diagnostic	On/Off
Trip Circuit Supervision (74TCS)	On/Off

METERING & RECORDING

Measured parameters

• Fundamental RMS phase currents	I_{L1}, I_{L2}, I_{L3}
• Fundamental RMS residual current	I_E

Circuit Breaker

• Position	Open - Close - Unknown
• Trip Circuit Supervision 74TCS	On/Off
• IN1 - 52b state	On/Off
• IN2 - 52a state	On/Off
• IN3 - TCS state	On/Off

Counters

- Start $I >$ element
- Start $I >>$ element
- Start $I >>>$ element
- Start $I_E >$ element
- Start $I_E >>$ element
- Trip $I >$ element
- Trip $I >>$ element
- Trip $I >>>$ element
- Trip $I_E >$ element
- Trip $I_E >>$ element

Event recorder

Number of events	100
Recording mode	circular
Trigger:	
• Output relays switching	K1...K4
• Binary inputs switching	IN1, IN2, IN3
• Setting changes	
Data recorded:	
• Event counter (resettable by ThyVisor)	0...10 ⁹
• Event cause	binary input/output relay/setting changes
• Time stamp	Date and time

Fault recorder

Number of events	20
Recording mode	circular
Trigger:	
• Output relays activation (OFF-ON transition)	K1...K4
• External trigger (binary inputs)	IN1, IN2, IN3
• Element pickup (OFF-ON transition)	Start/Trip
Data recorded:	
• Event counter (resettable by ThyVisor)	0...10 ⁹
• Fundamental RMS phase currents	I_{L1}, I_{L2}, I_{L3}
• Fundamental RMS residual current	I_E
• Event cause	start, trip
• Binary inputs state	IN1, IN2, IN3
• Output relays state	K1...K4
• Event cause info (operating phase)	L1, L2, L3
• Time stamp	Date and time

Settings recorder

Number of setting changes	10
Recording mode	circular
Data recorded:	
• Setting counter	0...10 ⁹
• Setting data	description and parameter
• Time stamp	Date and time

Digital Fault Recorder (Oscillography)^[1]

File format	COMTRADE
Records	2 ^[2]
Recording mode	circular
Sampling rate	16 per power frequency cycle

Trigger setup

• Pre-trigger time	0...63 T ^[3]
• Trigger from inputs	IN1, IN2, IN3
• Trigger from outputs	K1...K4
• General trigger from start / trip	Start, Trip
• Manual trigger	ThyVisor
• Trigger from start / trip	Start $I >$, $I >>$, ... Trip $I >$...

Data recorded on analog channels (Analog 1...4)

• Instantaneous currents	$i_{L1}, i_{L2}, i_{L3}, i_E$
• Fundamental RMS phase currents	I_{L1}, I_{L2}, I_{L3}
• Fundamental RMS residual current	I_E

Data recorded on digital channels (Digital 1...4)

• Binary inputs state	IN1, IN2, IN3
• Output relays state	K1...K4
• General trigger from start / trip	Start, Trip

Note 1 - The oscillography records are stored in non-volatile memory

Note 2 - the time duration of the two records is dependent of settings

Example, with settings:

- Instantaneous i_{L1} current into "Analog channel 1" i_{L1}
- Instantaneous i_{L2} current into "Analog channel 2" i_{L2}
- Instantaneous i_{L3} current into "Analog channel 3" i_{L3}
- Instantaneous i_E current into "Analog channel 4" i_E
- Diigital channel K1

the stored record duration with $f = 50$ Hz is 240 ms

Note 3 - $T =$ number of power cycles

Example, with settings $T=4$ the pre-trigger duration is 80 ms with $f = 50$ Hz

— Example of connection diagram with traditional CT inputs and acquisition of CB states for Data Logger

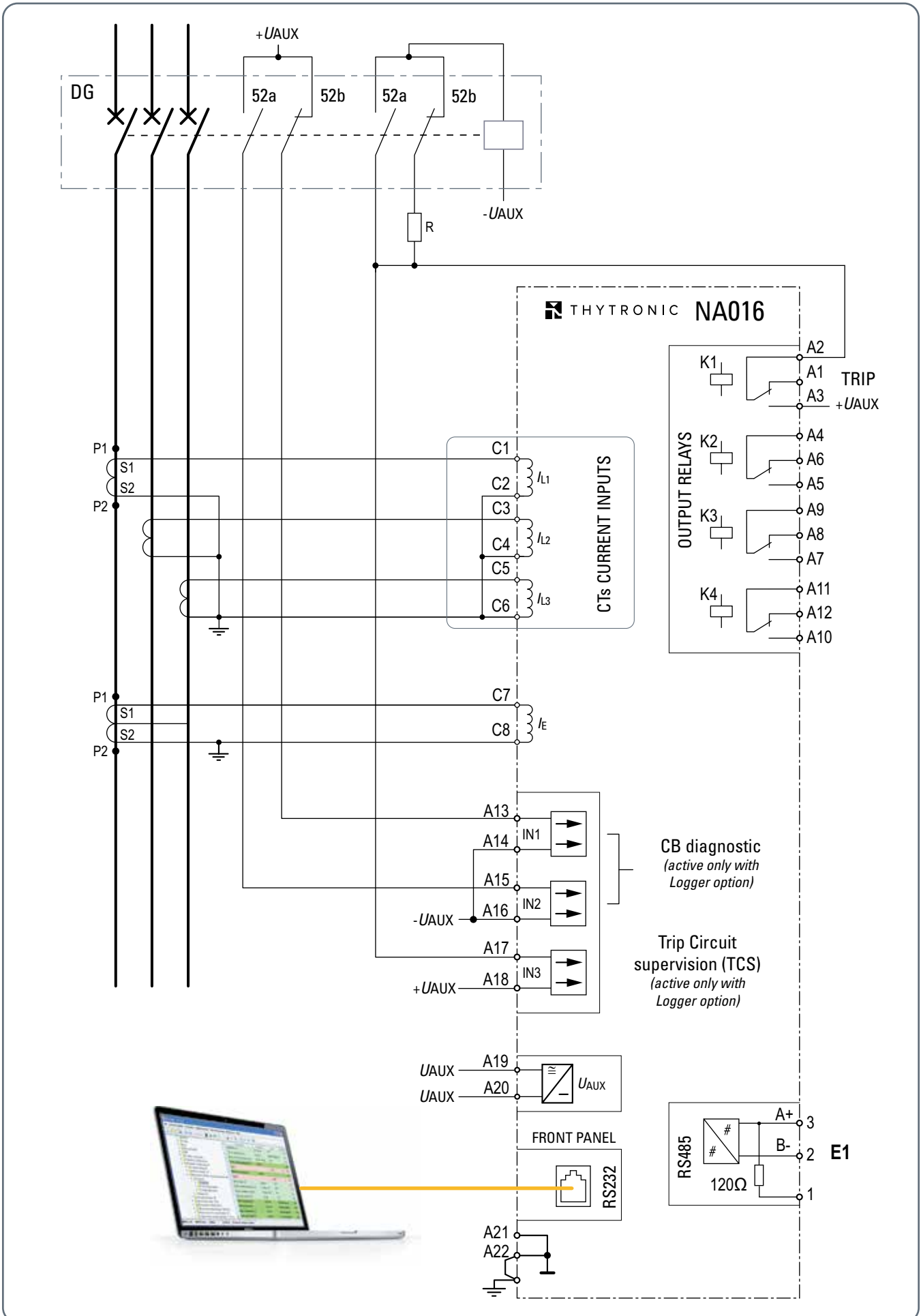

— Example of connection diagram with low power CT inputs and acquisition of CB states for Data Logger

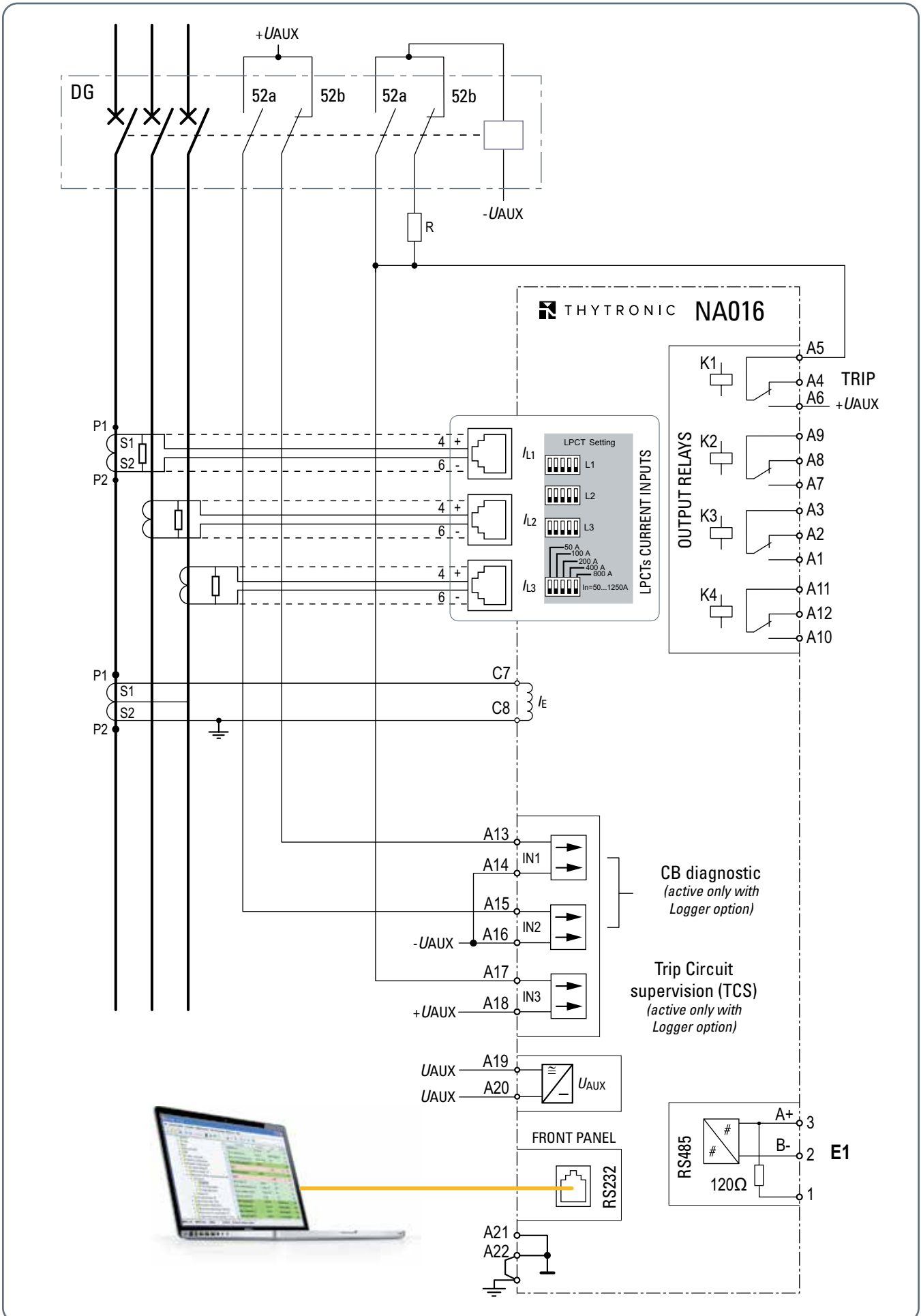

DIMENSIONS

FRONT VIEW

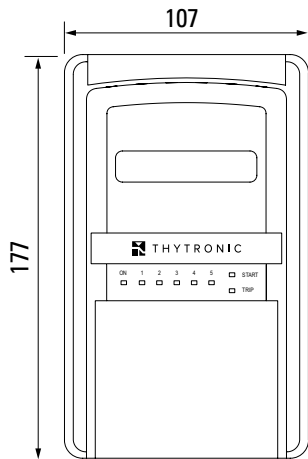

REAR VIEW

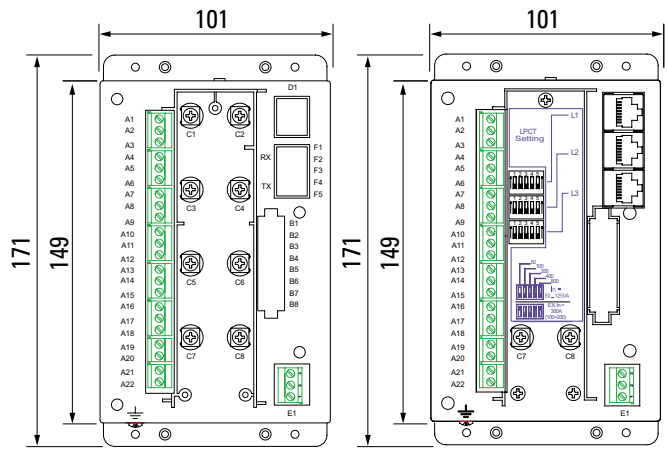

Traditional CT inputs

Low power CT inputs

SIDE VIEW

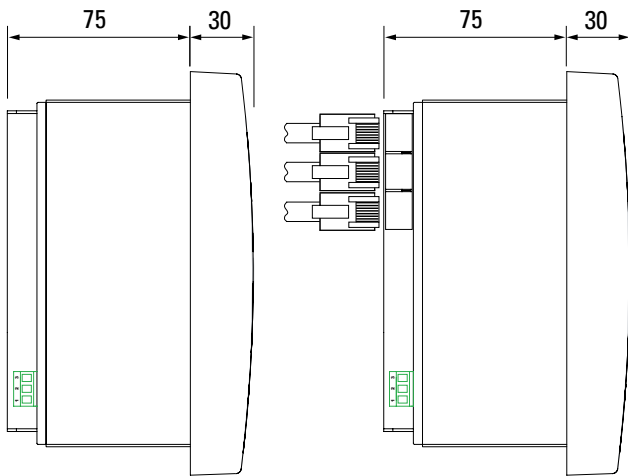

Traditional CT inputs

Low power CT inputs

FLUSH MOUNTING CUTOUT

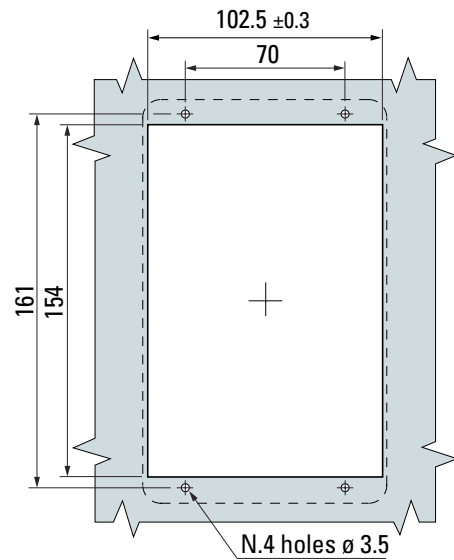

IDENTIFICATION LABEL

I_n	1A <input type="checkbox"/> 5A <input type="checkbox"/>
I_{En}	1A <input type="checkbox"/> 5A <input type="checkbox"/>
U_{AUX}	24-230 Vac/dc
1	50-51
2	50N-51N
3	CB OPEN
4	CB CLOSED
5	TCS
NA016#xx100	

Traditional CT inputs - Logger

I_n	1A <input type="checkbox"/> 5A <input type="checkbox"/>
I_{En}	1A <input type="checkbox"/> 5A <input type="checkbox"/>
U_{AUX}	24-230 Vac/dc
1	50-51
2	50N-51N
3	
4	
5	
NA016#xx000	

Traditional CT inputs - no Logger

I_n	Rated 50...500A/Extended 50...1250A
I_{En}	1A <input type="checkbox"/> 5A <input type="checkbox"/>
U_{AUX}	24-230 Vac/dc
1	50-51
2	50N-51N
3	CB OPEN
4	CB CLOSED
5	TCS
NA016#xx110	

Low power CT inputs - Logger

I_n	Rated 50...500A/Extended 50...1250A
I_{En}	1A <input type="checkbox"/> 5A <input type="checkbox"/>
U_{AUX}	24-230 Vac/dc
1	50-51
2	50N-51N
3	
4	
5	
NA016#xx010	

Low power CT inputs - no Logger

LEDS



ON: powered device and diagnostics OK
 START: start
 TRIP: trip

Note: the 3, 4 and 5 LEDs are active only with Logger option

Keys (CB open) and (CB close) are disabled



THYTRONIC
ENERGY FOR A SAFER FUTURE

A PERSONALISED SERVICE OF THE PRODUCTION, A RAPID DELIVERY, A COMPETITIVE PRICE AND AN ATTENTIVE EVALUATION OF OUR CUSTOMERS NEEDS, HAVE ALL CONTRIBUTED IN MAKING US ONE OF THE BEST AND MOST RELIABLE PRODUCERS OF PROTECTIVE RELAYS. FORTY YEARS OF EXPERIENCE HAS MADE STANDARD THESE ADVANTAGES THAT ARE GREATLY APPRECIATED BY LARGE COMPANIES THAT DEAL ON THE INTERNATIONAL MARKET. A HIGHLY QUALIFIED AND MOTIVATED STAFF PERMITS US TO OFFER AN AVANT-GARDE PRODUCT AND SERVICE WHICH MEET ALL SAFETY AND CONTINUITY DEMANDS, VITAL IN THE GENERATION OF ELECTRIC POWER. OUR COMPANY PHILOSOPHY HAS HAD A POSITIVE REACTION FROM THE MARKET BY BACKING OUR COMMITMENT AND HENCE STIMULATING OUR GROWTH.

www.thytronic.it